

LZ 60 - 34dB

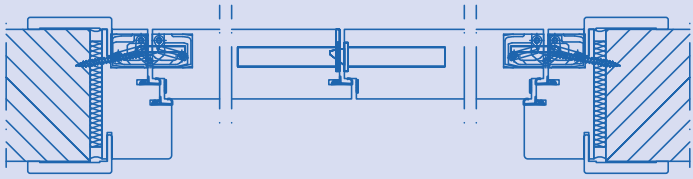

MATERIALI IN DOTAZIONE

Materials supplied | Matériaux fournis

A 4 x  Ø 8 mm

B 4 x  5x60 mm

C 1 x  20x1.4 mm

Leggere i documenti commessa

Read the contract documents | Lire les documents contractuels

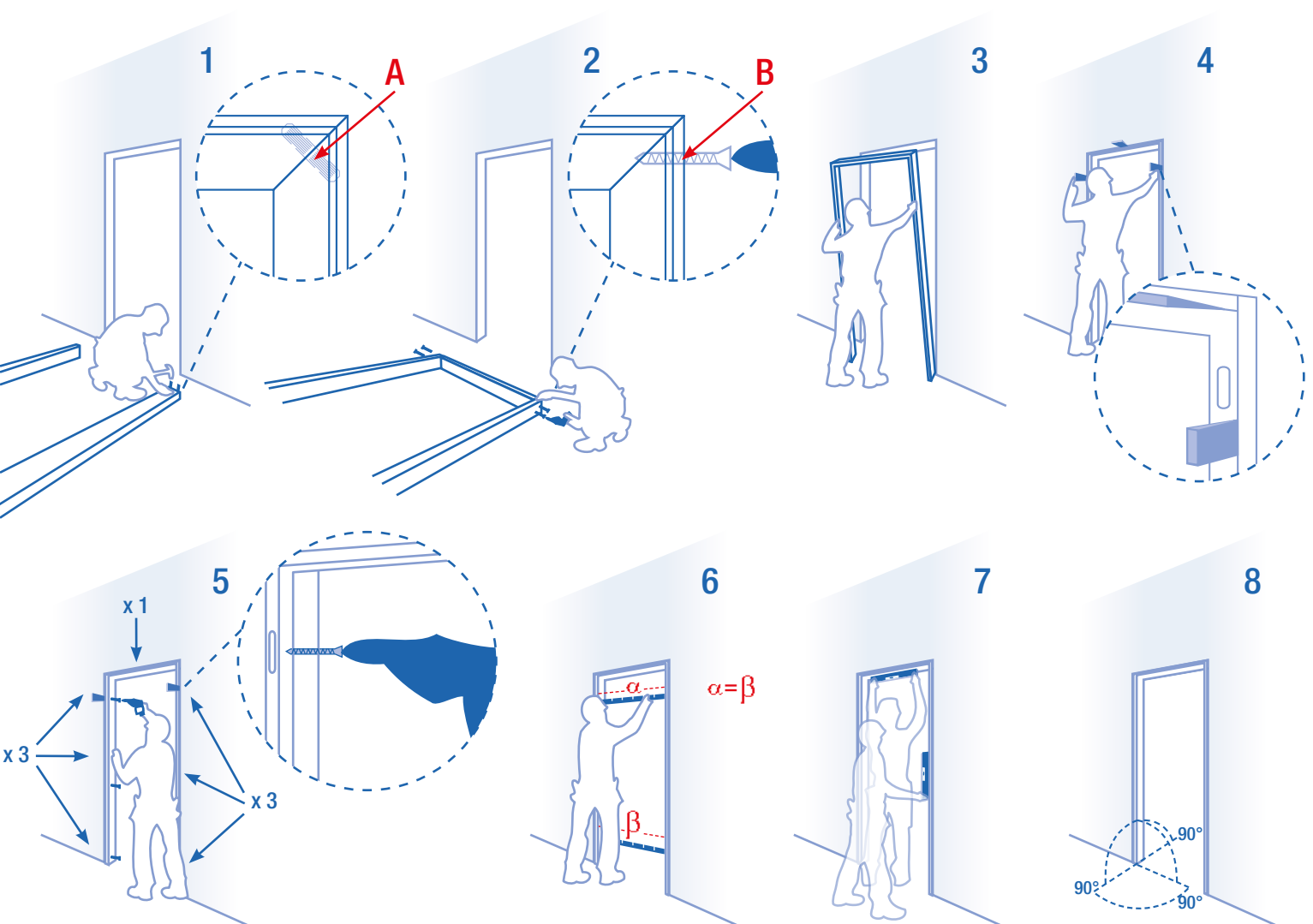



Opzional:
2 ante
2 leaves
2 vantaux

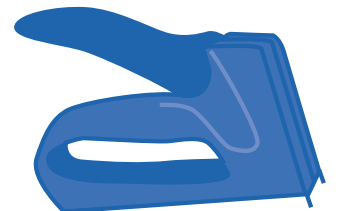
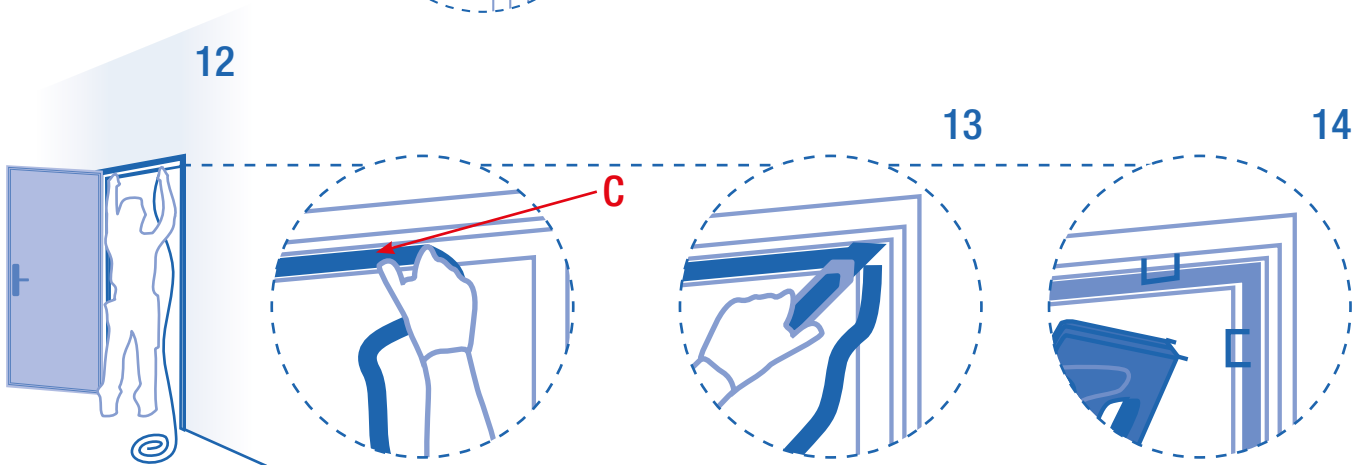
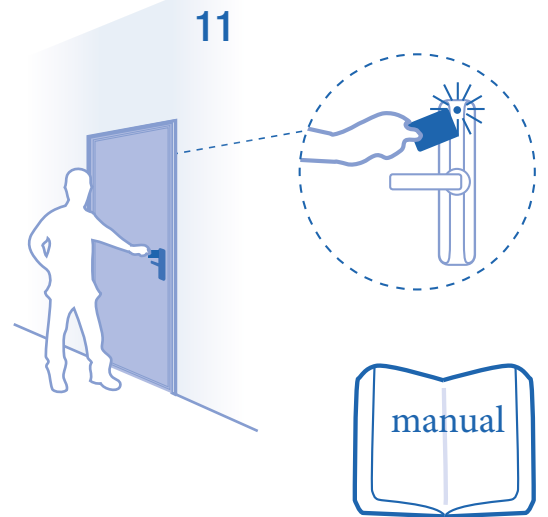
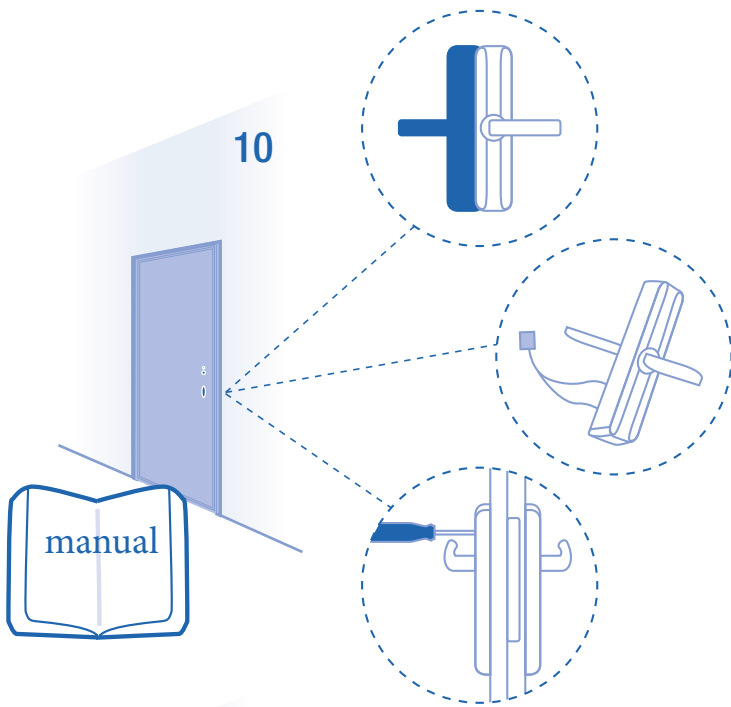
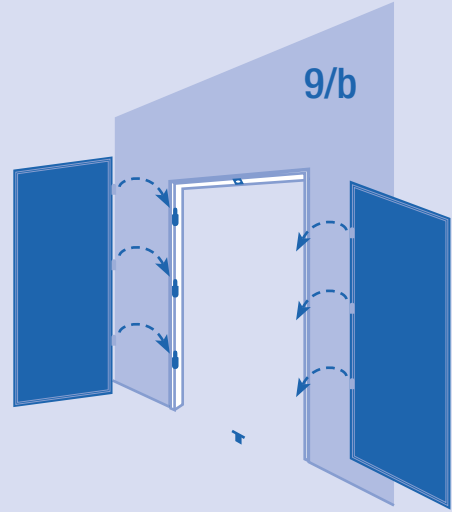

Torggler 6911 Sitol o equivalente
or equivalent
ou l'équivalent

15

OK

NO

16

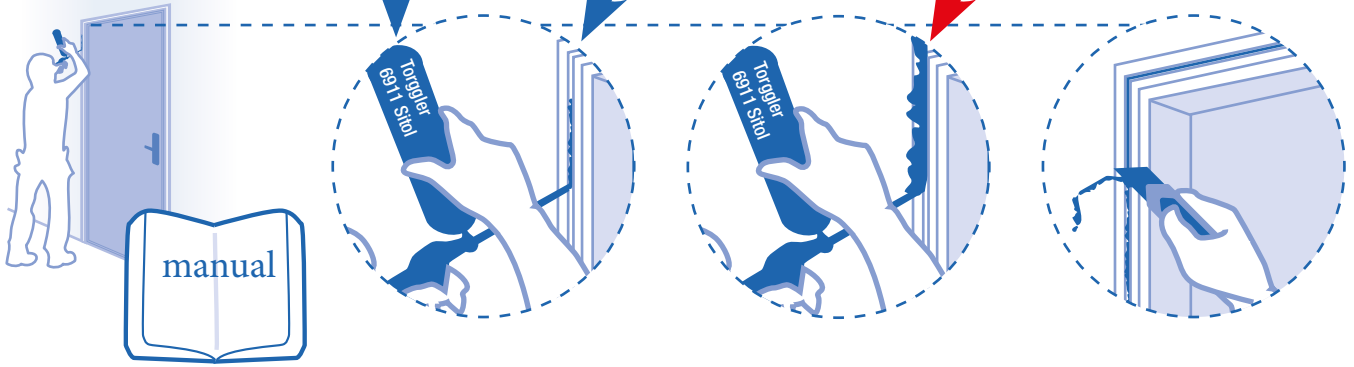

17

18

19

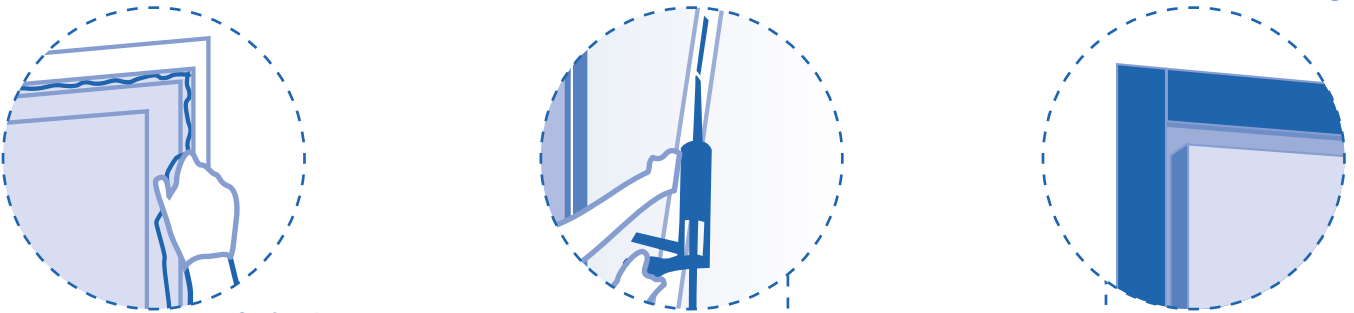

Opzional:
Stucco CFG art. V020
per Acustica
Stucco CFG art. V020
for Acoustic
Stuc CFG art. V020
pour l'Acoustique

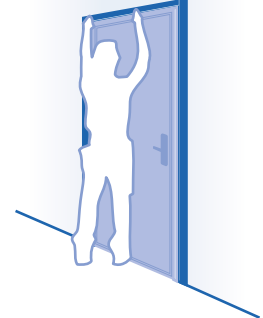
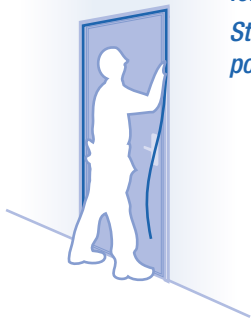

20

21

22

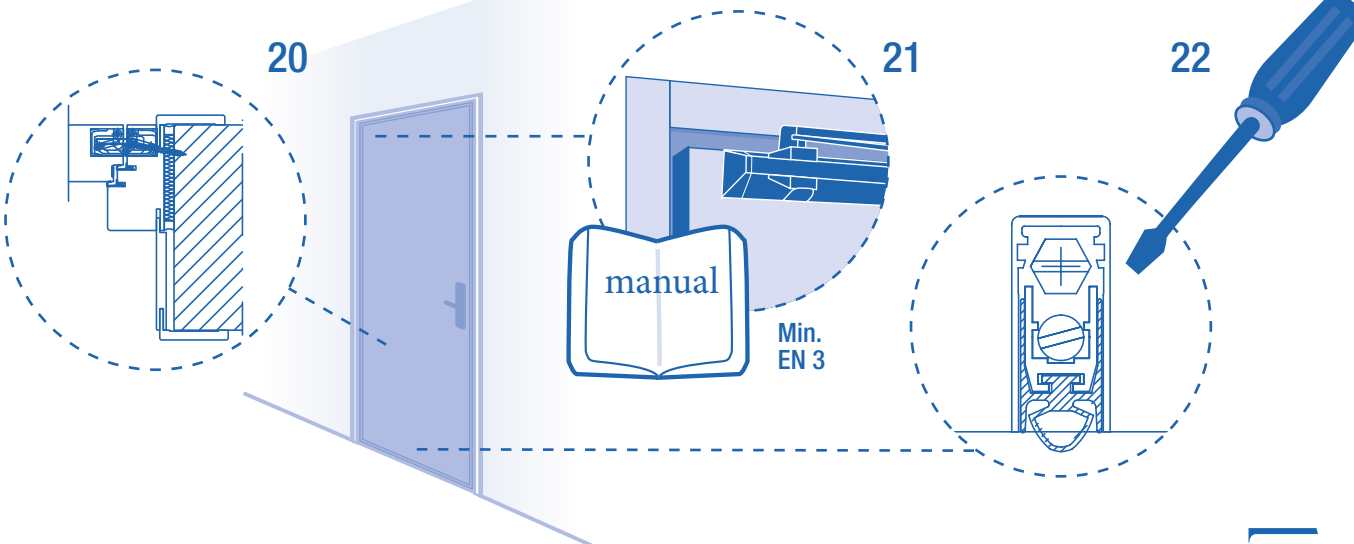

Min.
EN 3

OPZIONE VETRATURA

OPTION VITRAGE | OPTION GLAZING

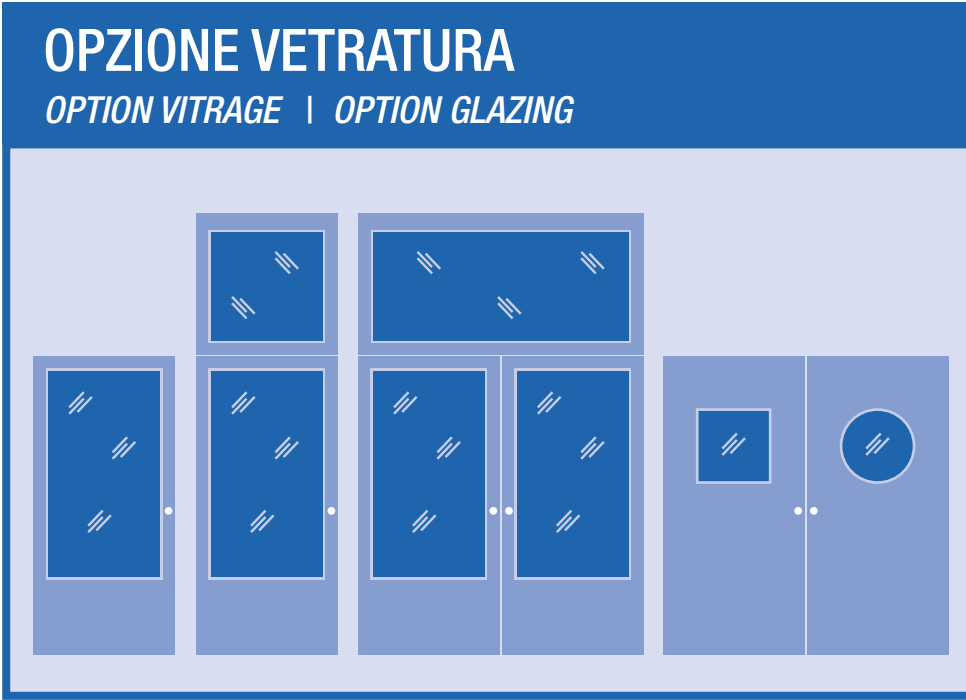

MATERIALI IN DOTAZIONE

Materials supplied

Matériaux fournis

D

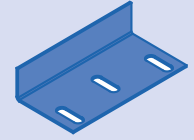

E

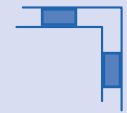

F



G

