

LZ 60 V&V

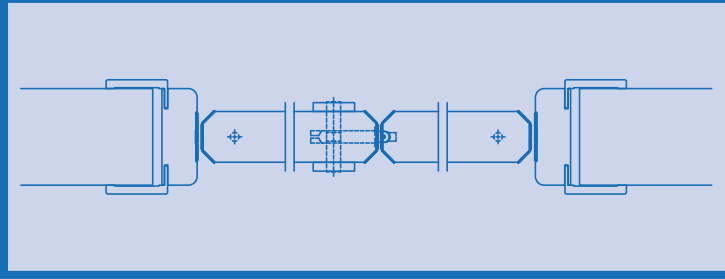

MATERIALI IN DOTAZIONE

Materials supplied | Matériaux fournis

A 4 x  Ø 8 mm

B 4 x  5x80 mm

B1 2 x **Kit Heco**

C 1 x  20x1.4 mm

1 x  15x1.4 mm

D 1 x  **Dima di foratura**
Drilling jig | Gabarit de perçage

Leggere i documenti commessa

Read the contract documents

Lire les documents contractuels

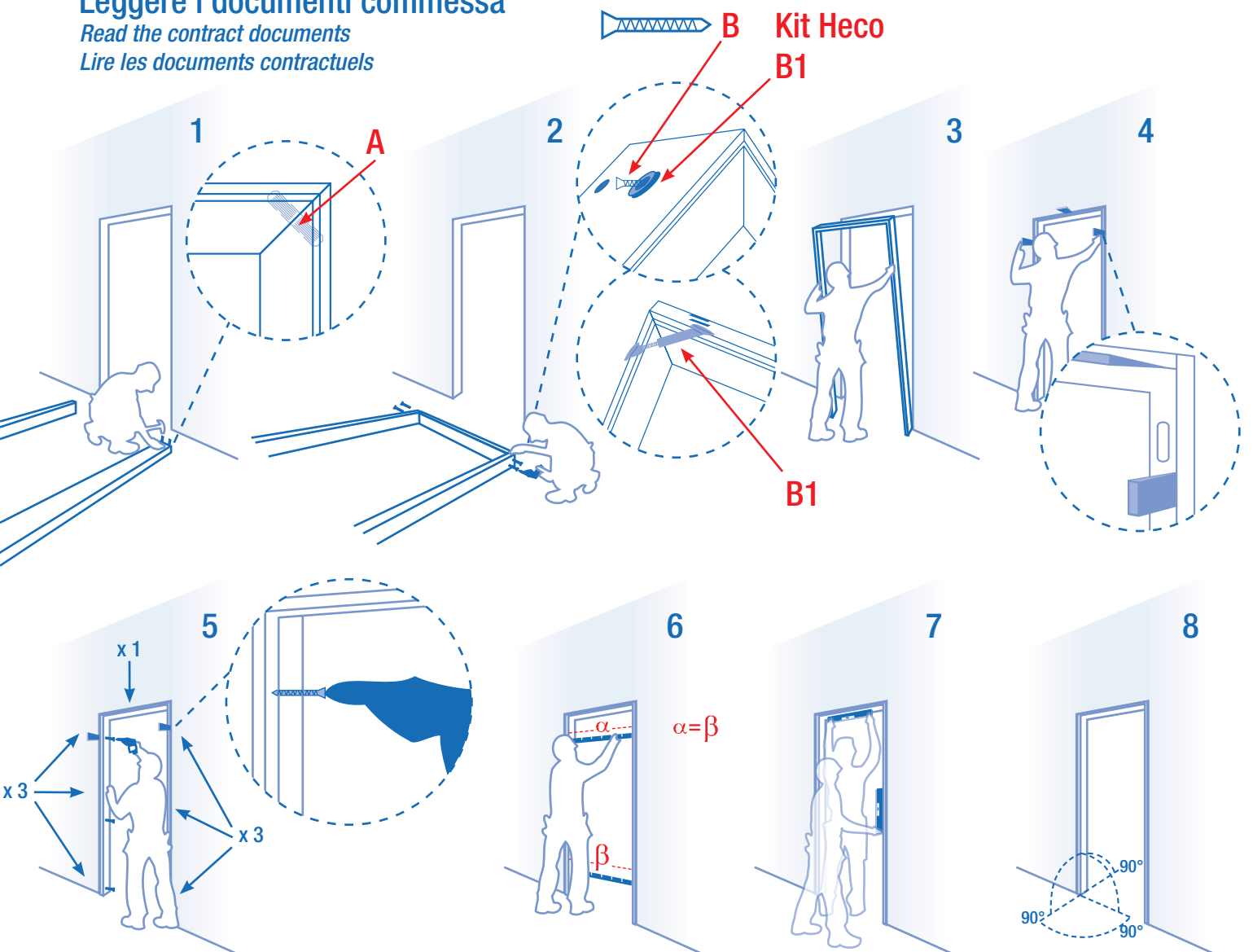

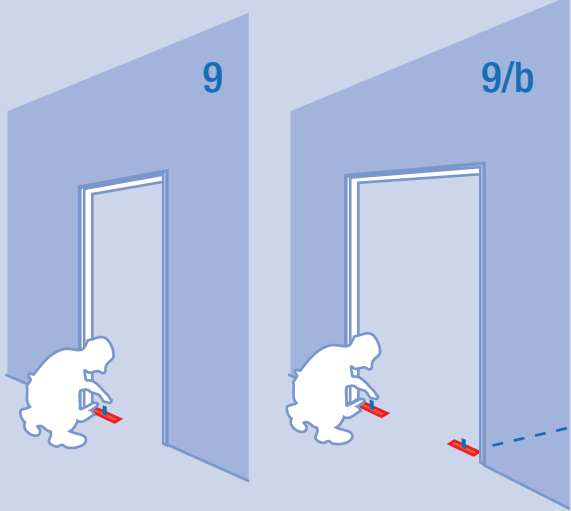

Opzionale:
2 ante
2 leaves
2 vantaux

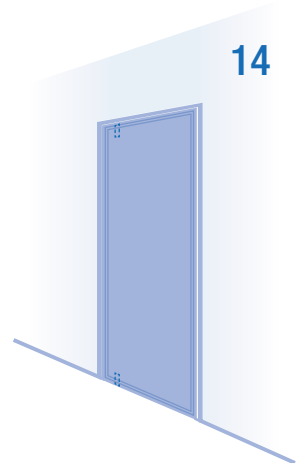
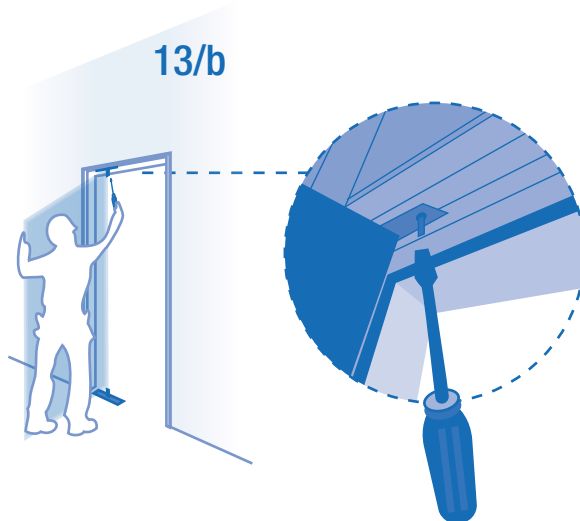
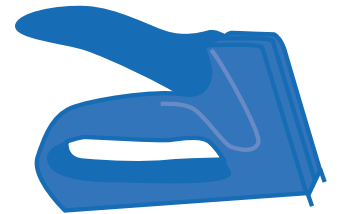
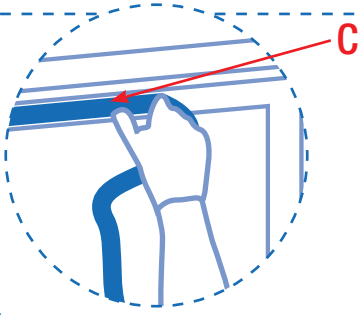
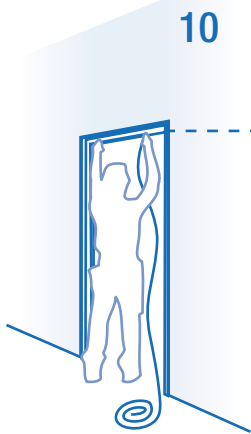
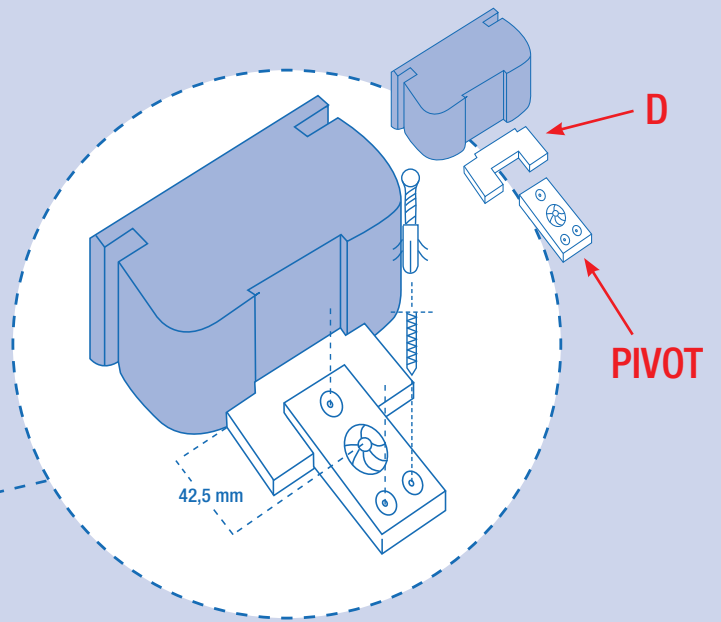

Torggler 6911 Sitol o equivalente
or equivalent
ou l'équivalent

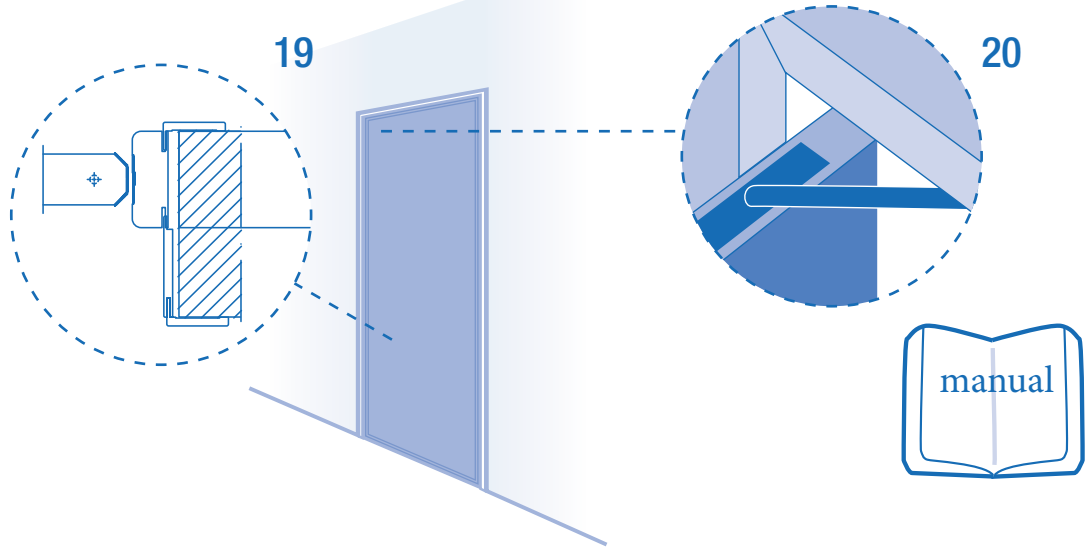
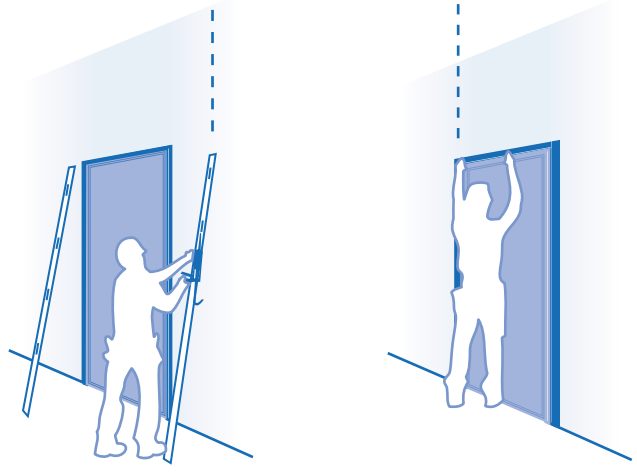
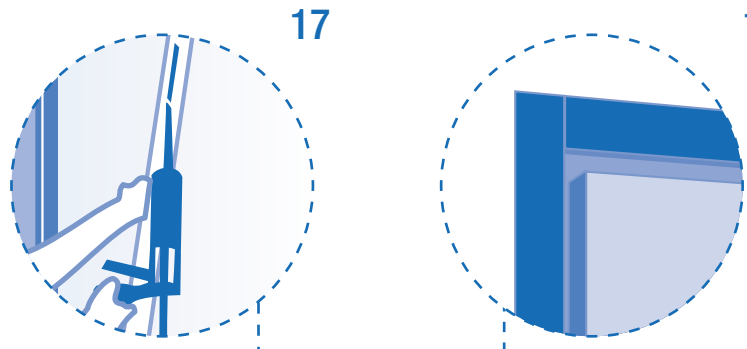
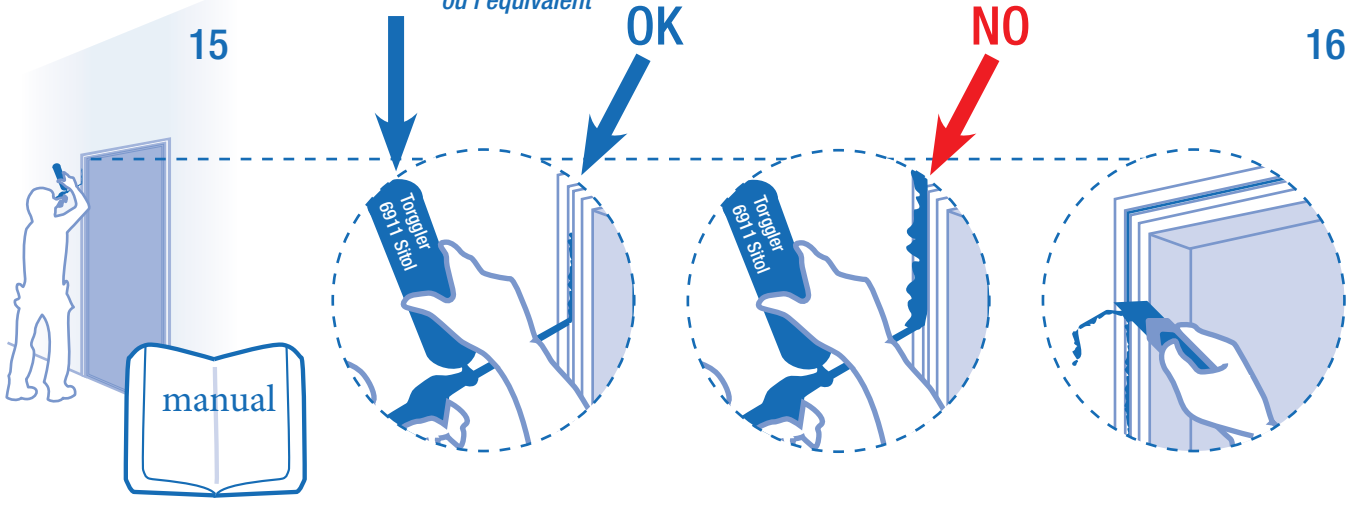

Min.
EN 3

OPZIONE VETRATURA

OPTION VITRAGE | OPTION GLAZING

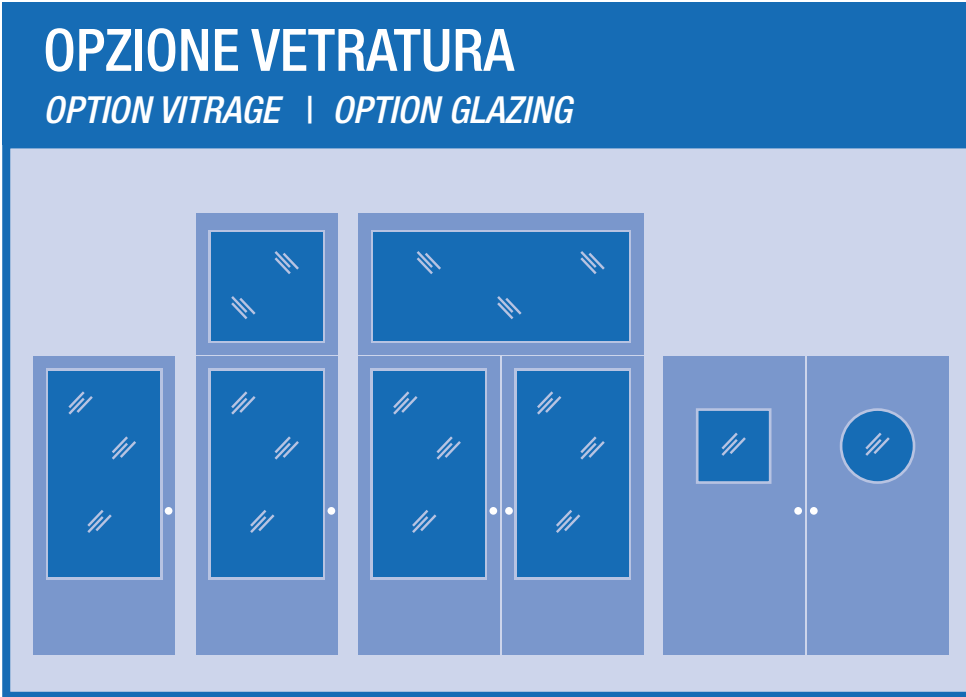

MATERIALI IN DOTAZIONE

Materials supplied

Matériaux fournis

D

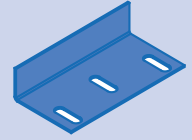

E

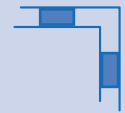

F



G

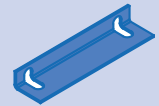

3.5x35 mm

